

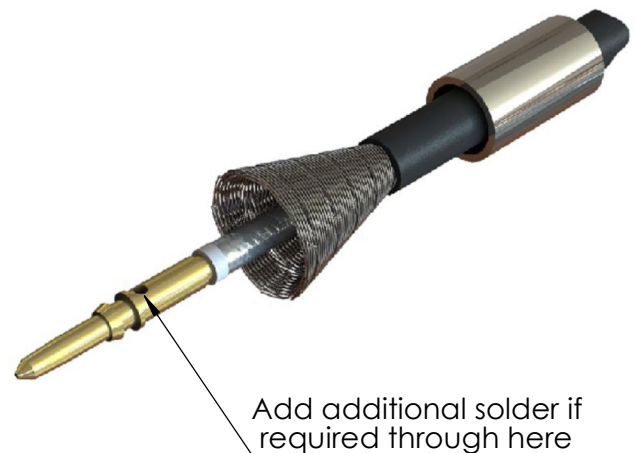

ASSEMBLY PROCEDURE : AP012

1. Slide the crimp sleeve onto the cable.
2. Strip the cable to the dimensions given on the connectors datasheet. If the cable has a foil screen please check the datasheet for the stripping length of this screen. Check to ensure the cables centre conductor is undamaged. Then using an appropriate solder, carefully Tin the centre conductor.
3. Fan the braid out slightly. Push the metal sleeve carefully over the dielectric and foil if applicable, but under the braid as shown. Slightly rotating the sleeve in the direction of the wrap of the foil as its inserted will help to keep the foil against the dielectric. Ensure centre conductor fully emerges undamaged with the dielectric being level with the end of the sleeve. Slide the small white insulator over the centre conductor and up against the sleeve and dielectric.
4. Slide the centre contact onto the tinned centre conductor up to insulator.
5. Ensure that the conductor is visible through the contact's inspection hole.
6. Carefully heat the Centre Contact using the appropriate tool, so that the solder melts, adding additional as required. Care should be taken not to overheat the contact to avoid damaging the Insulator or cable dielectric. Allow to cool and inspect joint.

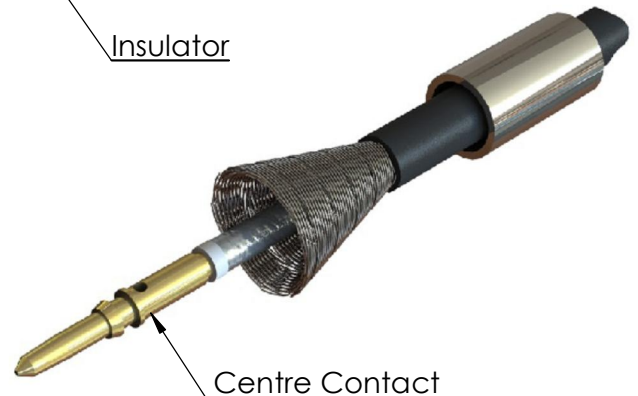
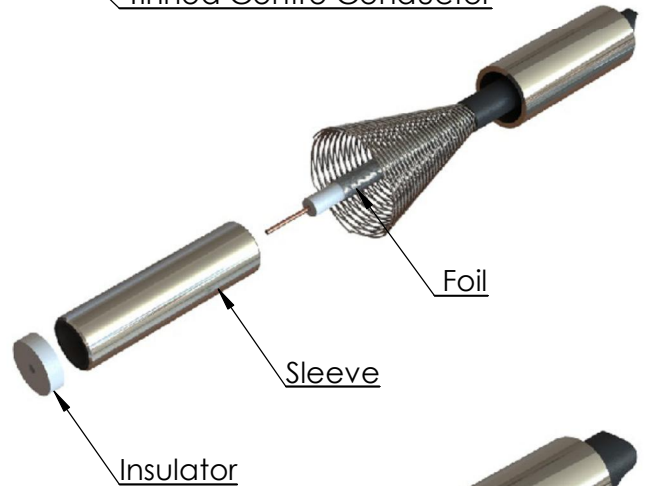
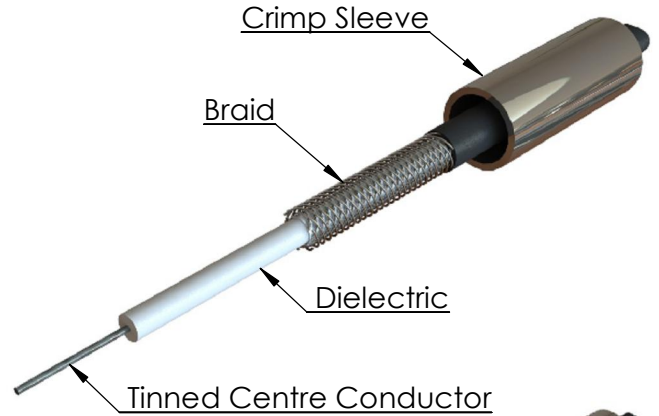

© 2010. THIS DOCUMENT IS THE PROPERTY OF OWNER. REPRODUCTION OR COMMUNICATION IN ANY FORM TO A THIRD PARTY IS PROHIBITED WITHOUT PRIOR WRITTEN CONSENT

A4	SHEET 1 OF 2		DIMENSIONS ARE IN MILLIMETERS		
REVISION :	A00		NAME	SIGNATURE	DATE
ISSUE :	1	DRAWN	GE		05/12/2010
		CHK'D	IG		05/12/2010
		APPV'D			
<p>6-8 COLNE ROAD, TWICKENHAM, MIDDLESEX. TW1 4JR</p> <p><small>THE INFORMATION IS GIVEN AS AN INDICATION ONLY AND IS SUBJECT TO CHANGE WITHOUT NOTICE. IN THE CONTINUAL GOAL TO IMPROVE OUR PRODUCTS, WE RESERVE THE RIGHT TO MAKE ANY MODIFICATIONS NECESSARY WITHOUT PRIOR NOTICE.</small></p>					

ASSEMBLY PROCEDURE : AP012

- Slide the cable into the connector and push home until the centre contact "CLICKS" into place in the connectors dielectric. Ensure all the braid strands pass outside over the knurled area of the connector.

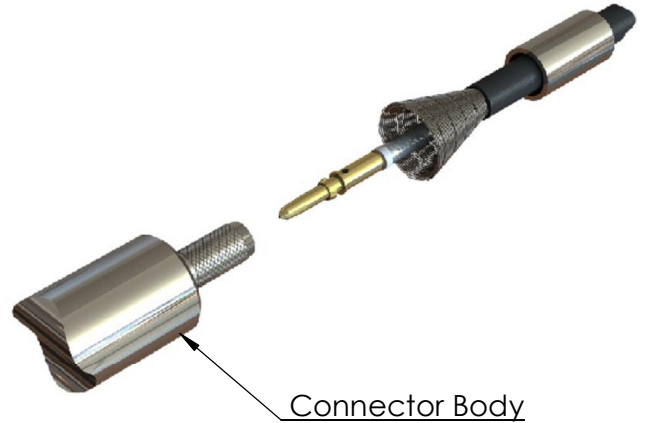

- Slide the crimp sleeve forward over the braid and knurled area of the connector to the rear of the connector body.
- Crimp the crimp sleeve using the appropriate sized crimp tool given on the connectors datasheet (trim excess braid if necessary)



- Carefully check the assembly.



© 2010. THIS DOCUMENT IS THE PROPERTY OF OWNER. REPRODUCTION OR COMMUNICATION IN ANY FORM TO A THIRD PARTY IS PROHIBITED WITHOUT PRIOR WRITTEN CONSENT

A4	SHEET 2 OF 2		DIMENSIONS ARE IN MILLIMETERS		
REVISION :	A00	NAME	SIGNATURE	DATE	
ISSUE :	1	DRAWN	GE		05/12/2010
		CHK'D	IG		05/12/2010
		APPV'D			
<p>6-8 COLNE ROAD, TWICKENHAM, MIDDLESEX. TW1 4JR</p> <p>THE INFORMATION IS GIVEN AS AN INDICATION ONLY AND IS SUBJECT TO CHANGE WITHOUT NOTICE. IN THE CONTINUAL GOAL TO IMPROVE OUR PRODUCTS, WE RESERVE THE RIGHT TO MAKE ANY MODIFICATIONS NECESSARY WITHOUT PRIOR NOTICE.</p>					